

MS SERIES

dual voice-coil subwoofer

MS-10SD2

MS-10SD4

MS-12SD2

MS-12SD4

MS-15SD2



OWNER'S MANUAL

THANK YOU for purchasing an MS Series subwoofer. Subwoofer installation requires woodworking skills and some experience in disassembling and reassembling automotive interiors. If you lack the tools or necessary skills, have your subwoofer installed by an authorized JBL® dealer.

WARNING: Playing loud music in an automobile can permanently damage your hearing as well as hinder your ability to hear traffic. We recommend listening at low levels while driving. We accept no liability for hearing loss, bodily injury or property damage resulting from use or misuse of this product.

CHOOSING AN ENCLOSURE

MS Series subwoofers are optimized to perform best in small, sealed and vented enclosures. While infinite-baffle mounting of MS subwoofers is possible, power handling will be greatly compromised because there will be no enclosed volume of air to prevent the speaker's cone from moving past its limit. For this reason, we do not recommend infinite-baffle mounting for MS subwoofers.

You should choose the enclosure you will use based on the type of music you listen to, how much amplifier power you will use for the subwoofer and how much space inside the vehicle you can devote to a subwoofer enclosure.

Because a sealed enclosure provides the most control over the woofer's movement, a woofer mounted in a sealed enclosure will handle more power than a woofer mounted in another enclosure type. Sealed enclosures provide more accurate sonic reproduction than other enclosure types when mounted inside a vehicle, so they are well suited to all types of music. Sealed-enclosure construction is straightforward, and there are many prefabricated sealed enclosures available. An optimum sealed enclosure is always smaller than other types of enclosures optimized for a particular speaker, so they require the smallest amount of space inside the vehicle.

Vented enclosures provide better efficiency in the 40Hz – 50Hz range, but this efficiency comes at the expense of sound in the lowest octave (below 40Hz) and at the expense of some control and power handling at the lowest frequencies. If you are using a small amplifier, a vented box will provide more perceived bass output from less power. Vented enclosures are also well suited to a variety of music types. Because vented enclosures require the volume of the enclosure and the size of the port to have a specific relationship with the characteristics of the woofer, the enclosure must be built exactly to the specifications provided. While there are some prefabricated vented boxes available, matching a prefabricated box to a particular woofer is difficult. If you wish to use a vented enclosure, we strongly recommend having your authorized JBL dealer build it or verify that your design is correct if you wish to build it yourself. An optimum vented enclosure is always larger than the optimum sealed box for the same woofer and will require more space inside the vehicle.

CONNECTING YOUR SUBWOOFER TO YOUR AMPLIFIER

JBL MS Series subwoofers are available in two different configurations: a dual two-ohm voice coil or dual four-ohm voice coils. You may use MS subwoofers in singles or multiples to maximize the power available from your amplifier(s). To achieve the maximum amplifier output possible, you should design a speaker system that provides the lowest impedance that your amplifier will drive safely. When designing a subwoofer system, consider the following rules:

1. Do not mix different subwoofers or enclosure types in the same system. Subwoofers being used in the same enclosure or powered by the same amplifier should be identical models. Mismatched woofers and enclosures can result in poor performance from your subwoofer system.

- You must use both coils of a dual voice-coil woofer connected either in series or in parallel.
- Most amplifiers deliver exactly the same amount of power bridged into a 4-ohm load as they do running a 2-ohm stereo load.

To design a subwoofer system that maximizes available amplifier power, keep the following rules in mind:

- The total system impedance of woofers in parallel can be calculated using this formula:

$$\text{Impedance} = \frac{1}{\frac{1}{w_1} + \frac{1}{w_2} + \frac{1}{w_3} \dots}$$

where w is the nominal impedance of the woofer.

- The total system impedance of voice coils (or woofers) in series can be calculated using this formula:

$$\text{Impedance} = w_1 + w_2 + w_3 \dots$$

The diagrams below show parallel and series speaker connections.

Figure 1: Parallel connection

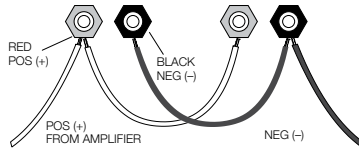
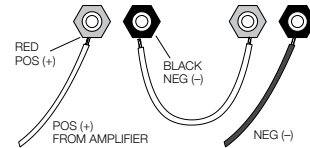

Figure 2: Series connection



SUGGESTED ENCLOSURES

MODELS SEALED BOX

Internal Volume

VENTED BOX

Internal Volume Qty. Duct(s) Diameter x Length

MS-10SD2	0.78 ft ³ (22L)	1.13 ft ³ (32L)	1	2.95 in x 9.84 in (7.5cm x 25cm)
MS-10SD4	0.78 ft ³ (22L)	1.13 ft ³ (32L)	1	2.95 in x 9.84 in (7.5cm x 25cm)
MS-12SD2	0.95 ft ³ (27L)	1.7 ft ³ (48L)	1	3.94 in x 8.66 in (10cm x 22cm)
MS-12SD4	0.95 ft ³ (27L)	1.7 ft ³ (48L)	1	3.94 in x 8.66 in (10cm x 22cm)
MS-15SD2	1.27 ft ³ (36L)	2.12 ft ³ (60L)	2	3.94 in x 14.96 in (10cm x 38cm)

- The suggested enclosure volumes are related to only one speaker, including woofer and duct(s) displaced volume.
- For enclosures with more than one speaker, it is necessary to multiply the suggested volume and duct(s) by the quantity of speakers.

ENCLOSURES INTERNAL VOLUME CALCULATION INSTRUCTIONS

RECTANGULAR BOX

$$\text{Internal Volume} = \frac{A \times B \times C}{1000}$$

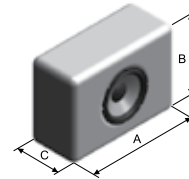

TRAPEZOID RECTANGULAR BOX

$$\text{Internal Volume} = \frac{A \times B \times \left(\frac{C + D}{2}\right)}{1000}$$

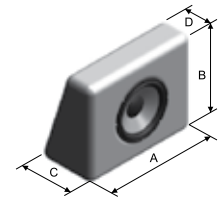

- A, B and C are internal dimensions.

**RESPONSE CURVES (0° AND 45°) IN A TEST ENCLOSURE
INSIDE AN ANECHOIC CHAMBER, 1W/1M**

**HARMONIC DISTORTION CURVES MEASURED AT 10%
NOMINAL POWER INPUT**

MS-10SD2

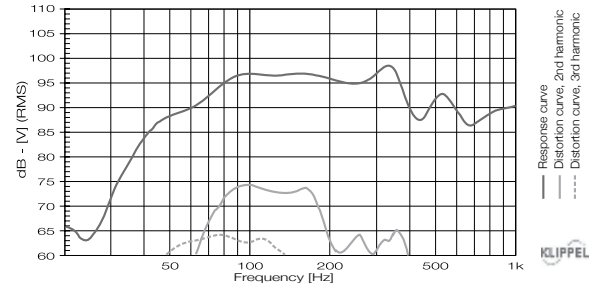
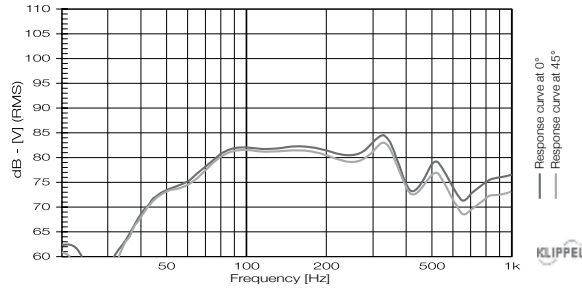

MS-10SD4

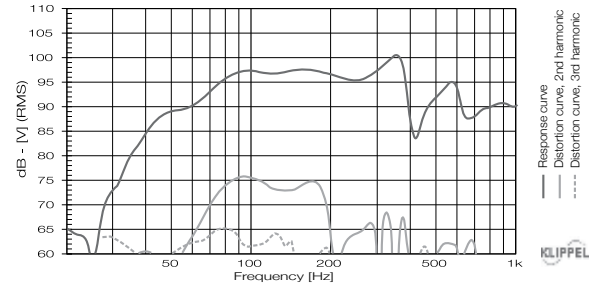
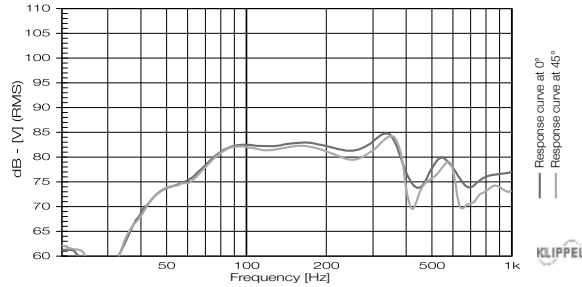

MS-12SD2

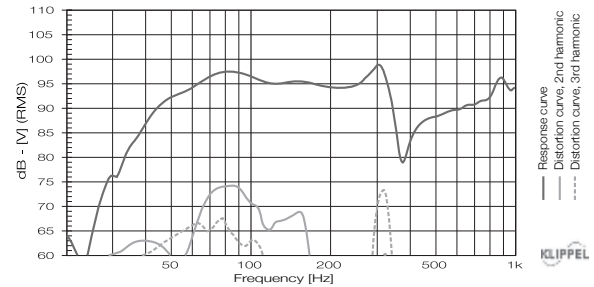
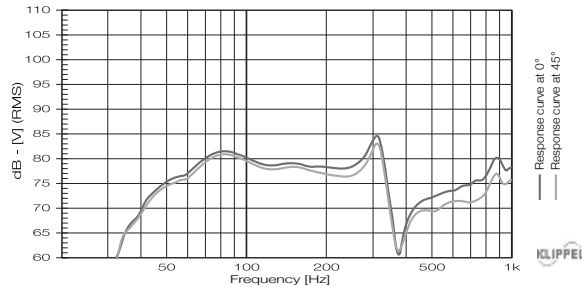

IMPEDANCE AND PHASE CURVES MEASURED IN FREE AIR

SOFTWARE SIMULATED RESPONSE CURVE

MS-10SD2

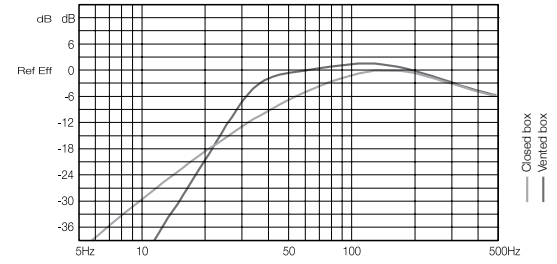
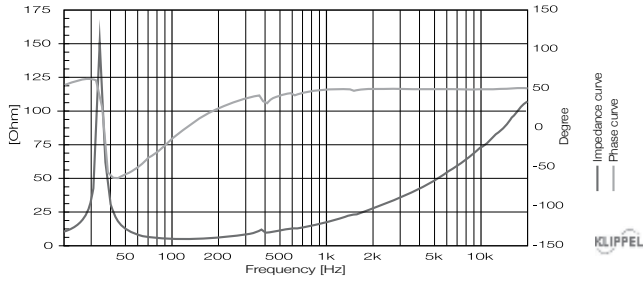

MS-10SD4

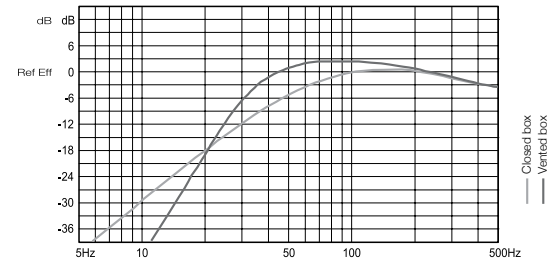
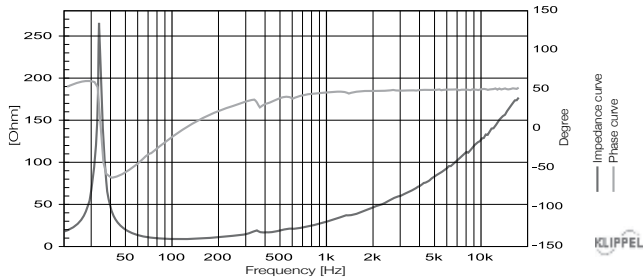

MS-12SD2

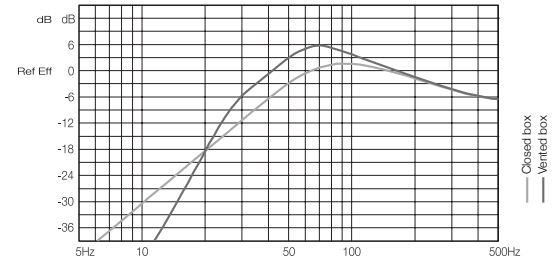
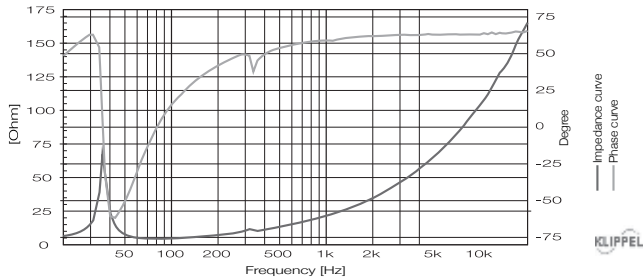

**RESPONSE CURVES (0° AND 45°) IN A TEST ENCLOSURE
INSIDE AN ANECHOIC CHAMBER, 1W/1M**

MS-12SD4

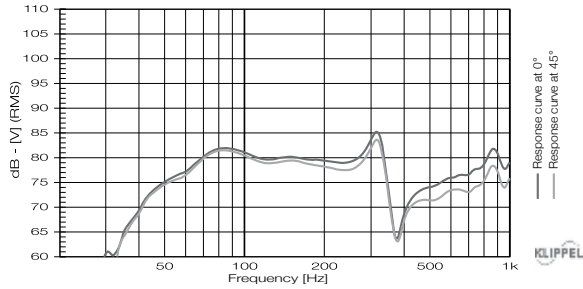

**HARMONIC DISTORTION CURVES MEASURED AT 10%
NOMINAL POWER INPUT**

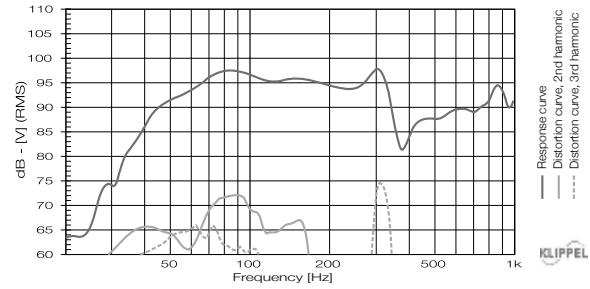

MS-15SD2

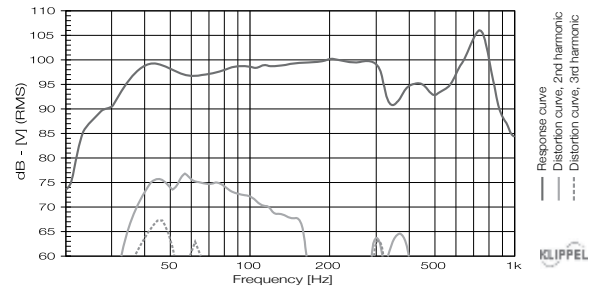
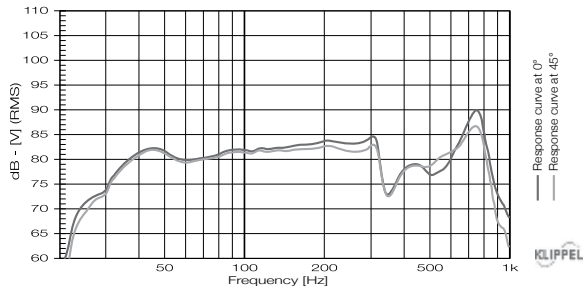

IMPEDANCE AND PHASE CURVES MEASURED IN FREE AIR

SOFTWARE SIMULATED RESPONSE CURVE

MS-12SD4

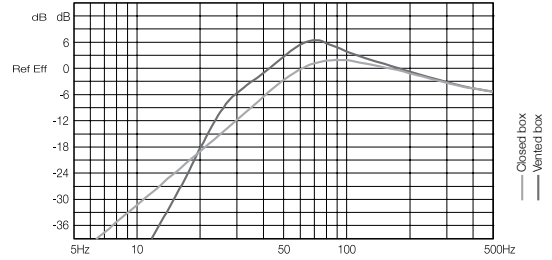
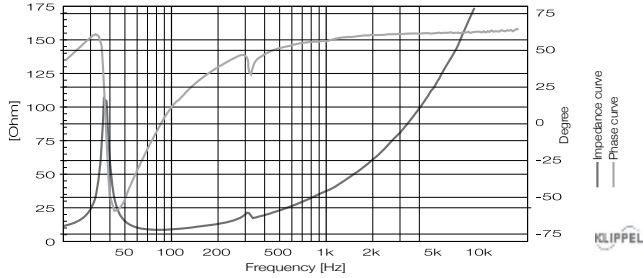

MS-15SD2

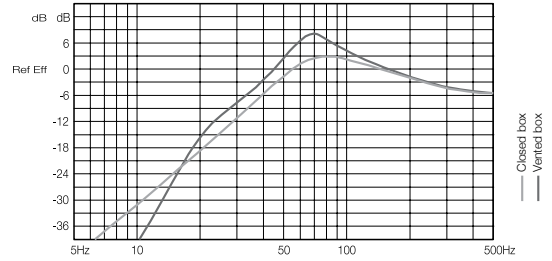
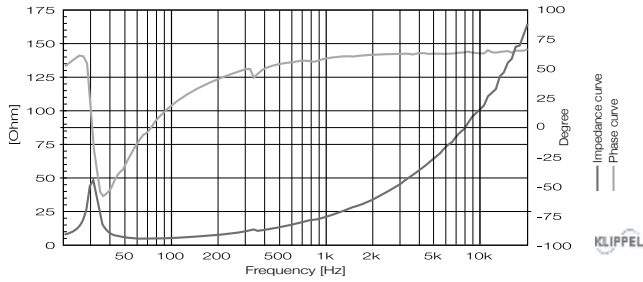

SPECIFICATIONS	MS-10SD2	MS-10SD4	MS-12SD2	MS-12SD4	MS-15SD2
Nominal diameter:	10 in (254mm)	10 in (254mm)	12 in (305mm)	12 in (305mm)	15 in (381mm)
Nominal impedance:	2+2 ohms	4+4 ohms	2+2 ohms	4+4 ohms	2+2 ohms
Minimum impedance @ 105Hz:	4.5 ohms	9 ohms	4.4 ohms	8.7 ohms	4.2 ohms
Power handling					
Peak:	1,200W	1,200W	1,800W	1,800W	1,800W
Continuous music ¹ :	600W	900W	900W	900W	900W
NBR ² :	300W	300W	450W	450W	450W
AES ³ :	250W	250W	350W	350W	350W
Sensitivity (1W @ 1m):	87dB SPL	87dB SPL	87dB SPL	87dB SPL	87dB SPL
Power compression @ 0dB (nom. power):	3.8dB	3.8dB	4.5dB	5.0dB	3.6dB
Power compression @ -3dB (nom. power)/2:	2.8dB	2.8dB	2.5dB	3.6dB	2.3dB
Power compression @ -10dB (nom. power)/10:	2.7dB	2.7dB	0.5dB	1.8dB	1.0dB
Frequency response @ -10dB:	40Hz – 400Hz	40Hz – 400Hz	30Hz – 400Hz	30Hz – 400Hz	30Hz – 1kHz
THIELE-SMALL PARAMETERS					
Fs:	34Hz	34Hz	35Hz	37Hz	29Hz
Vas:	1.30 ft ³ (37L)	1.38 ft ³ (39L)	1.73 ft ³ (49L)	1.66 ft ³ (47L)	4.58 ft ³ (130L)
Qts:	0.39	0.48	0.73	0.86	0.82
Qes:	0.40	0.49	0.78	0.93	0.87
Qms:	16.49	18.56	10.08	10.45	13.25
Ho (half space):	0.35%	0.30%	0.27%	0.27%	0.36%
Sd:	51.16 in ² (0.03301m ²)	51.16 in ² (0.03301m ²)	78.59 in ² (0.0507m ²)	78.59 in ² (0.0507m ²)	128.52 in ² (0.083m ²)
Vd (Sd x X _{max}):	12.08 in ³ (198cm ³)	12.08 in ³ (198cm ³)	20.08 in ³ (329cm ³)	21.6 in ³ (354cm ³)	32.88 in ³ (539cm ³)
X _{max} (max. excursion (peak) with 10% distortion):	0.23 in (6mm)	0.23 in (6mm)	0.25 in (6.5mm)	0.27 in (7mm)	0.25 in (6.5mm)
X _{lin} (max. excursion (peak) before physical damage):	0.77 in (19.5mm)	0.77 in (19.5mm)	1.15 in (29.3mm)	1.15 in (29.3mm)	1.15 in (29.3mm)
Atmospheric conditions at TS parameter measurements					
Temperature:	77°F (25°C)	77°F (25°C)	77°F (25°C)	77°F (25°C)	77°F (25°C)
Atmospheric pressure:	1.047mb	1.047mb	1.047mb	1.047mb	1.047mb
Humidity:	51%	51%	51%	51%	51%

– ¹Power handling specifications refer to normal speech and/or music program material, reproduced by an amplifier producing no more than 5% distortion.

– Power is calculated as true RMS voltage squared divided by the nominal impedance of the loudspeaker.

– ²NBR Standard (10,303 Brazilian Standard).

– ³AES Standard (60Hz – 600Hz).

– Thiele-Small parameters are measured after a two-hour power test using half AES power. A variation of ±17% is allowed.

ADDITIONAL PARAMETERS	MS-10SD2	MS-10SD4	MS-12SD2	MS-12SD4	MS-15SD2
βL:	13.3Tm	16.6Tm	12.6Tm	16.3Tm	13.2Tm
Flux density:	0.8T	0.9T	0.6T	0.7T	0.6T
Voice-coil diameter:	1.92 in (49mm)	1.92 in (49mm)	2.51 in (64mm)	2.51 in (64mm)	2.51 in (64mm)
Voice-coil winding length:	101.7 ft (31m)	101.7 ft (31m)	104.22 ft (31.8m)	129.6 ft (39.5m)	104.22 ft (31.8m)
Wire temperature coefficient of resistance (α25):	0.00358 1/°C	0.00372 1/°C	0.00388 1/°C	0.00344 1/°C	0.00388 1/°C
Maximum voice-coil operation temperature:	534.2°F (279°C)	534.2°F (279°C)	458.6°F (237°C)	564.8°F (296°C)	465.8°F (241°C)
Θvc (max. voice-coil operation temp./max. power):	2.15°F/W (-16.6°C/W)	2.15°F/W (-16.6°C/W)	1.31°F/W (-17.1°C/W)	1.61°F/W (-16.9°C/W)	1.31°F/W (-17.1°C/W)
Hvc (voice-coil winding depth):	0.79 in (20mm)	0.79 in (20mm)	0.83 in (21mm)	0.87 in (22mm)	0.82 in (21mm)
Hag (air gap height):	0.31 in (8mm)	0.31 in (8mm)	0.31 in (8mm)	0.31 in (8mm)	0.31 in (8mm)
Re:	3.7 ohms	7.4 ohms	3.7 ohms	7.7 ohms	3.7 ohms
Mms:	0.2 lb (91.6g)	0.19 lb (85.8g)	0.33 lb (149g)	0.3 lb (136.4g)	0.47 lb (223.1g)
Cms:	240μm/N	250μm/N	130μm/N	130μm/N	130μm/N
Rms:	1.2kg/s	1kg/s	3.3kg/s	3.1kg/s	3.1kg/s
NON-LINEAR PARAMETERS					
Le @ Fs (voice-coil inductance @ Fs):	5.297mH	11.644mH	6.193mH	9.692mH	6.594mH
Le @ 1kHz (voice-coil inductance @ 1kHz):	2.4352mH	3.6917mH	3.076mH	5.2016mH	3.2527mH
Le @ 20kHz (voice-coil inductance @ 20kHz):	1.2227mH	1.3332mH	1.639mH	2.944mH	1.7867mH
Red @ Fs:	0.34 ohms	0.91 ohms	0.26 ohms	0.43 ohms	0.23 ohms
Red @ 1kHz:	6.96 ohms	11.12 ohms	8.75 ohms	15.18 ohms	8.91 ohms
Red @ 20kHz:	100.11 ohms	102.04 ohms	203.32 ohms	397.46 ohms	200.89 ohms
Krm:	2.9 mohm	17.2 mohm	0.9 mohm	1.1 mohm	1 mohm
Kxm:	18.2mH	72.2mH	19.3mH	27.4mH	18.7mH

ADDITIONAL INFORMATION	MS-10SD2	MS-10SD4	MS-12SD2	MS-12SD4	MS-15SD2
Magnet material:	Barium ferrite	Barium ferrite	Barium ferrite	Barium ferrite	Barium ferrite
Magnet weight:	2.73 lb (1.24kg)	2.73 lb (1.24kg)	3.525 lb (1.6kg)	3.525 lb (1.6kg)	3.525 lb (1.6kg)
Magnet diameter x depth:	5.79 in x 0.71 in (147mm x 18mm)	5.79 in x 0.71 in (147mm x 18mm)	6.65 in x 0.74 in (169mm x 19mm)	6.65 in x 0.74 in (169mm x 19mm)	6.65 in x 0.74 in (169mm x 19mm)
Magnetic assembly weight:	7.32 lb (3.32kg)	7.32 lb (3.32kg)	9.04 lb (4.1kg)	9.04 lb (4.1kg)	9.04 lb (4.1kg)
Frame material:	Aluminum	Aluminum	Aluminum	Aluminum	Aluminum
Frame finish:	Black epoxy	Black epoxy	Black epoxy	Black epoxy	Black epoxy
Voice-coil material:	Copper	Copper	Copper	Copper	Copper
Voice-coil former material:	Kapton®	Kapton	Fiberglass	Fiberglass	Fiberglass
Cone material:	Polypropylene	Polypropylene	Polypropylene	Polypropylene	Polypropylene
Volume displaced by woofer:	0.07 ft³ (2.2L)	0.07 ft³ (2.2L)	0.13 ft³ (3.78L)	0.13 ft³ (3.78L)	0.18 ft³ (5.1L)
Net weight:	8.95 lb (4.06kg)	8.95 lb (4.06kg)	11.9 lb (5.44kg)	11.9 lb (5.44kg)	13 lb (5.96kg)
Gross weight:	10.32 lb (4.68kg)	10.32 lb (4.68kg)	13.84 lb (6.28kg)	13.84 lb (6.28kg)	15.63 lb (7.1kg)
Carton dimensions (W x D x H):	13.2 in x 11.4 in x 6.9 in (335mm x 290mm x 175mm)	13.2 in x 11.4 in x 6.9 in (335mm x 290mm x 175mm)	15.3 in x 13.6 in x 7.9 in (390mm x 345mm x 200mm)	15.3 in x 13.6 in x 7.9 in (390mm x 345mm x 200mm)	18.1 in x 16.3 in x 8.9 in (460mm x 415mm x 225mm)

MOUNTING INFORMATION

Number of bolt-holes:	8	8	8	8	8
Bolt-hole diameter:	0.25 in x 0.31 in (6.5mm x 8mm)	0.25 in x 0.31 in (6.5mm x 8mm)	0.25 in x 0.31 in (6.5mm x 8mm)	0.25 in x 0.31 in (6.5mm x 8mm)	0.25 in x 0.31 in (6.5mm x 8mm)
Bolt-circle diameter:	9.57 in (243mm)	9.57 in (243mm)	11.5 in (292mm)	11.5 in (292mm)	14.4 in (367mm)
Baffle cutout diameter (front mount):	9.05 in (230mm)	9.05 in (230mm)	11 in (280mm)	11 in (280mm)	13.8 in (353mm)
Baffle cutout diameter (rear mount):	8.97 in (228mm)	8.97 in (228mm)	10.9 in (277mm)	10.9 in (277mm)	13.7 in (350mm)
Connectors:	Silver-plated push terminals	Silver-plated push terminals	Silver-plated push terminals	Silver-plated push terminals	Silver-plated push terminals
Polarity:	Positive voltage applied to the positive terminal (red) gives forward cone motion.	Positive voltage applied to the positive terminal (red) gives forward cone motion.	Positive voltage applied to the positive terminal (red) gives forward cone motion.	Positive voltage applied to the positive terminal (red) gives forward cone motion.	Positive voltage applied to the positive terminal (red) gives forward cone motion.
Minimum clearance between the back of the magnetic assembly and the enclosure wall:	3 in (75mm)	3 in (75mm)	3 in (75mm)	3 in (75mm)	3 in (75mm)

DIMENSIONS

MS-10SD2, MS-10SD4

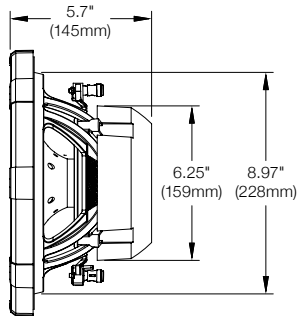
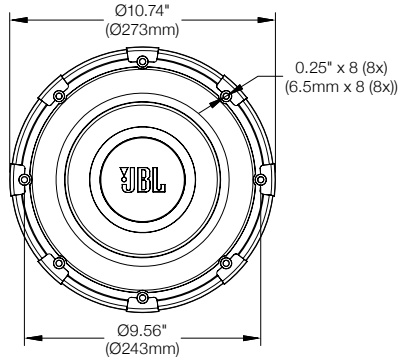

MS-12SD2, MS-12SD4

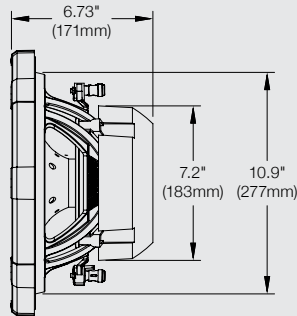
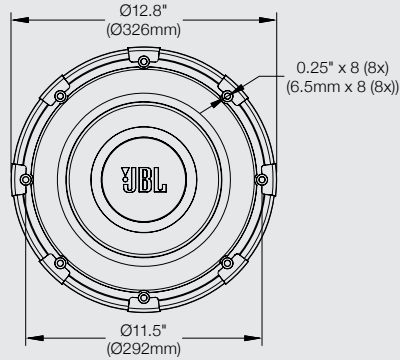

MS-15SD2

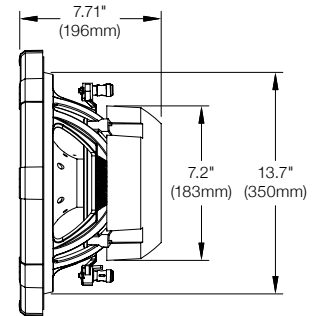
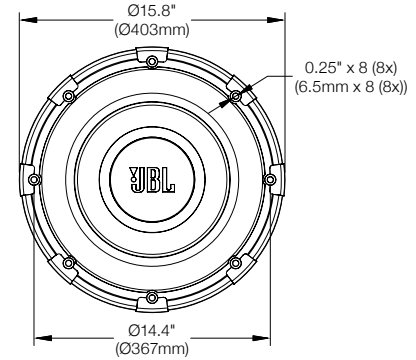



HARMAN

HARMAN Consumer, Inc.
8500 Balboa Boulevard, Northridge, CA 91329 USA

© 2011 HARMAN International Industries, Incorporated. All rights reserved.
JBL is a trademark of HARMAN International Industries, Incorporated, registered
in the United States and/or other countries. Kapton is a registered trademark of
E.I. du Pont de Nemours and Company. Features, specifications and appearance
are subject to change without notice.

www.jbl.com